

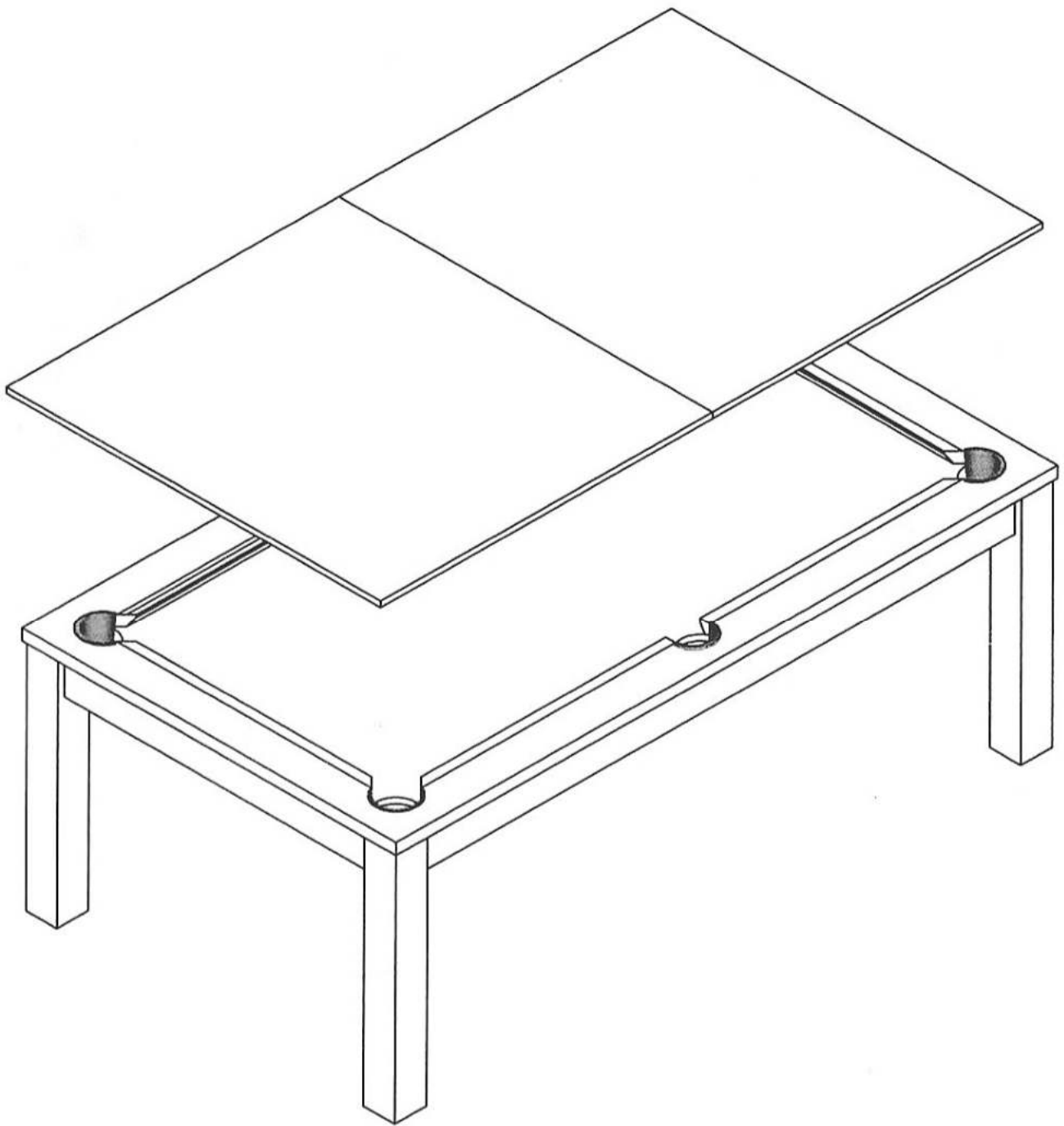









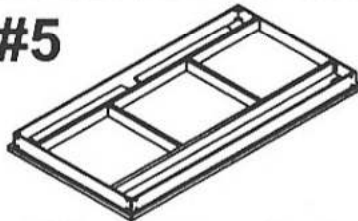
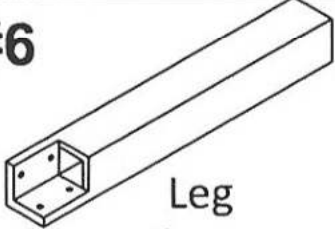
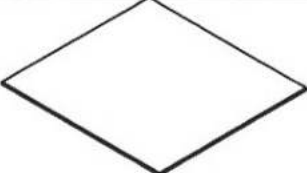

# POOL TABLE BECOME TABLE

# INSTRUCTIONS

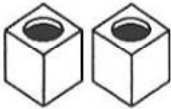

---

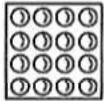
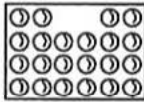
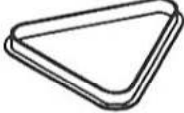

# PARTS IDENTIFIER

<p><b>#1</b></p>  <p>5/16" Bolt 16 pcs</p>	<p><b>#2</b></p>  <p>5/16" Washer 16 pcs</p>	<p><b>#3</b></p>  <p>Leg leveler 4pcs</p>
<p><b>#4</b></p>  <p>Tool 1 pc</p>	<p><b>#5</b></p>  <p>Billiard table 1set</p>	<p><b>#6</b></p>  <p>Leg 4 pcs</p>
<p><b>#7</b></p>  <p>Dining table 2pcs</p>	<p><b>#8</b></p>  <p>Shaker 1pc</p>	<p><b>#9</b></p>  <p>Dice 1set</p>
<p><b>#10</b></p>  <p>Chalk 2 pcs</p>	<p><b>#11</b></p>  <p>Brush 1 pc</p>	<p><b>#12</b></p>  <p>Wood plug 2 pcs</p>
<p><b>#13</b></p>  <p>Cue stick 4pcs</p>	<p><b>#14</b></p>  <p>Cross bar 1pc</p>	<p><b>#15</b></p>  <p>Crown bar 1pc</p>
<p><b>#16</b></p>  <p>2-1/4" Billiard ball 1set</p>	<p><b>#17</b></p>  <p>2-1/16" Billiard ball 1set</p>	<p><b>#18</b></p>  <p>2-1/4" Triangle rack 1 pc</p>

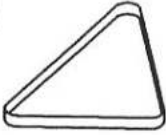
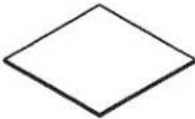
# PARTS IDENTIFIER

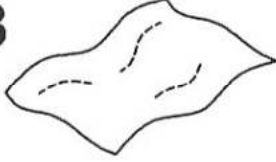
<b>#19</b>  2-1/16" Triangle rack 1 pc	<b>#20</b>  Gasket 2 pcs	<b>#21</b>  Scoreboard 1 pc
<b>#22</b>  Wooden cue holder 1 set	<b>#23</b>  Table cover 1 set	

## ASSEMBLY INSTRUCTIONS

WARNING: TWO ADULTS NEEDED ASSEMBLE POOL TABLE

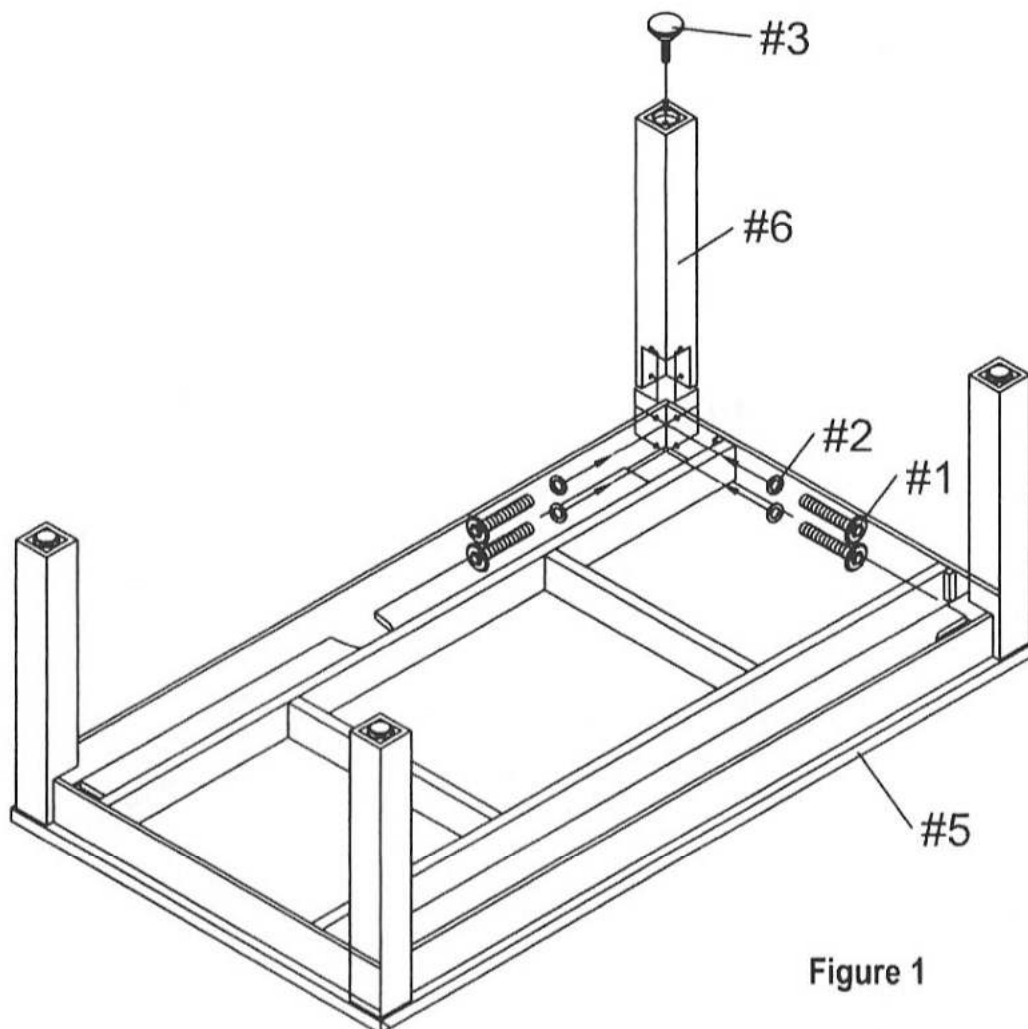

Figure 1

# ASSEMBLY INSTRUCTIONS

WARNING: TWO ADULTS NEEDED ASSEMBLE POOL TABLE

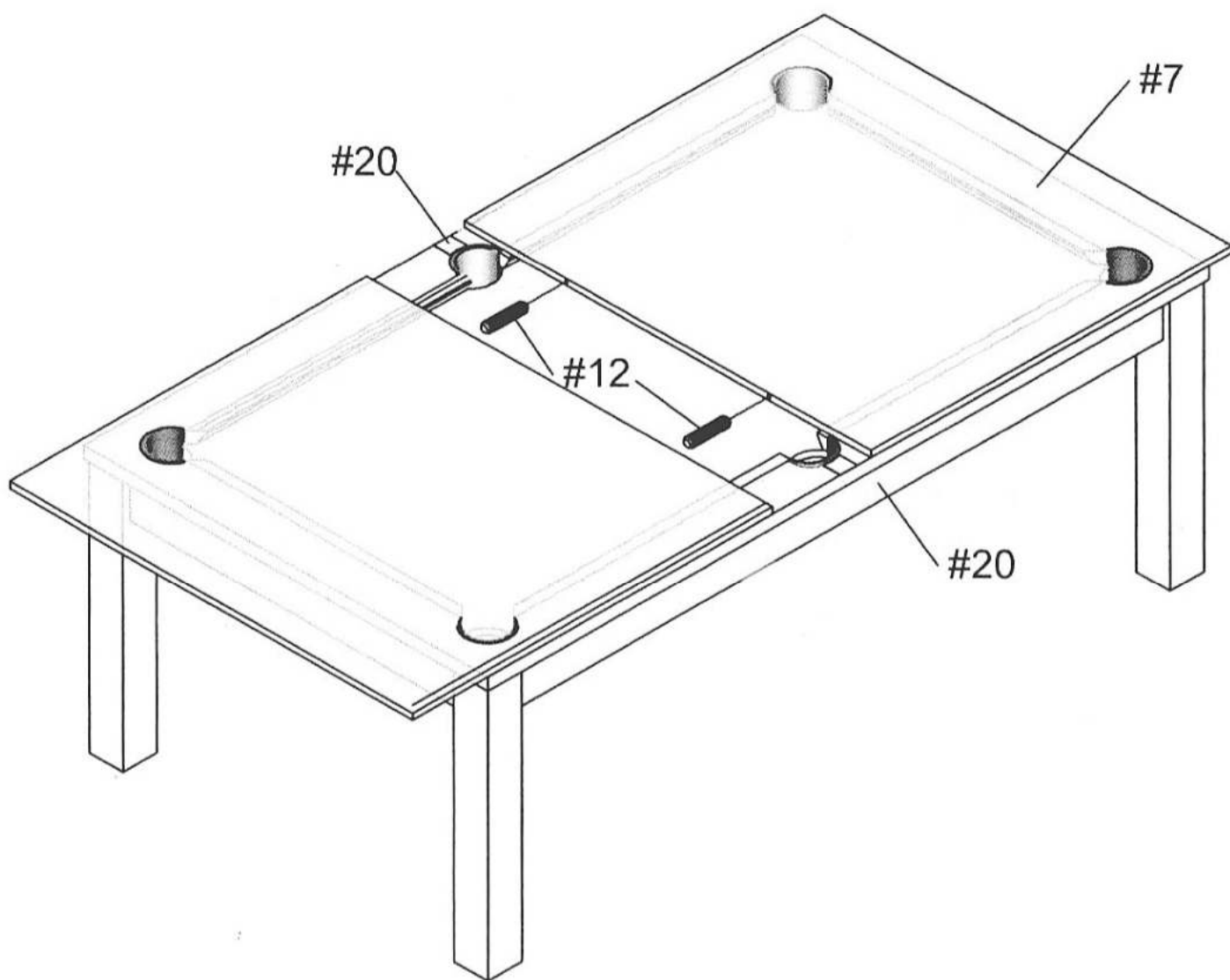

Figure 2