

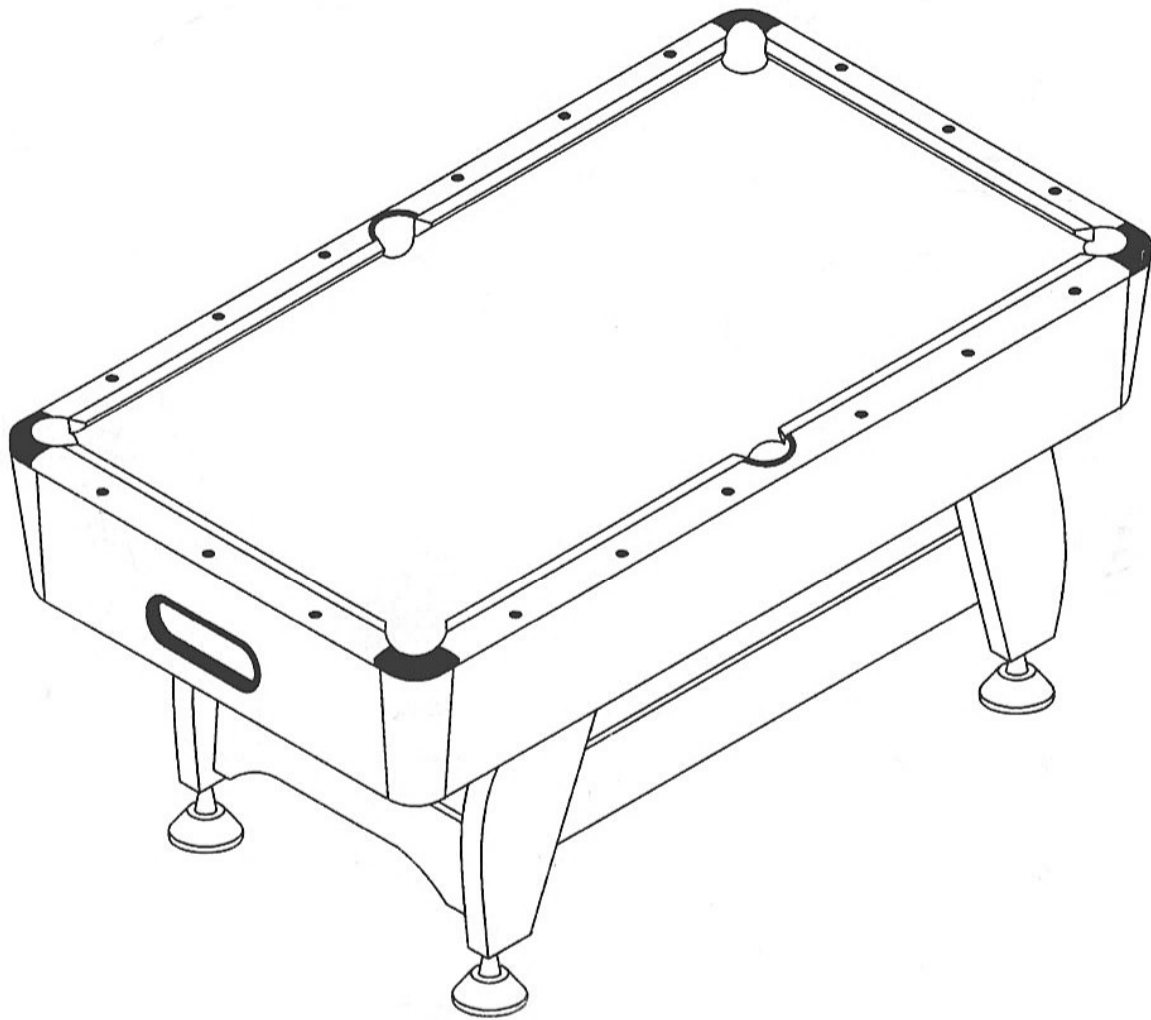

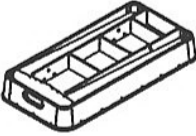









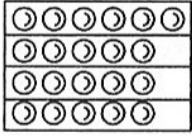
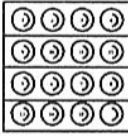
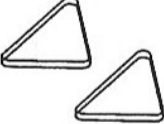
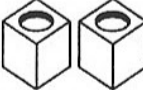



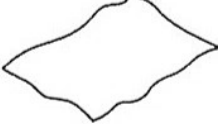

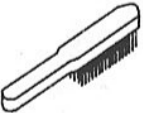
POOL TABLE 7FT

INSTRUCTIONS

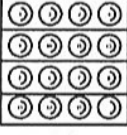
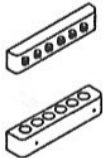

PART LIST

<p>#1</p>  <p>Main frame 1 piece</p>	<p>#2</p>  <p>Left leg 2 pieces</p>	<p>#3</p>  <p>Right leg 2 pieces</p>	<p>#4</p>  <p>Leg end panels 2 pieces</p>	<p>#5</p>  <p>Leg side panels 2 pieces</p>
<p>#6</p>  <p>Snooker balls 1 set</p>	<p>#7</p>  <p>Billiard ball 1 set</p>	<p>#8</p>  <p>Triangle 2 pieces</p>	<p>#9</p>  <p>Chalk 2 pieces</p>	<p>#10</p>  <p>Cue stick 4 pieces</p>
<p>#11</p>  <p>Cue stick A 1 piece</p>	<p>#12</p>  <p>Cue stick B 1 piece</p>	<p>#13</p>  <p>Dust cover 1 piece</p>	<p>#14</p>  <p>Leg leveler 4 pieces</p>	<p>#15</p>  <p>Tool 1 piece</p>
<p>#16</p>  <p>Brush 1 piece</p>	<p>#17</p>  <p>5/16" Bolt 12 pieces</p>	<p>#18</p>  <p>5/16" Washer 12 pieces</p>	<p>#19</p>  <p>1/4" Bolt 8 pieces</p>	<p>#20</p>  <p>1/4" Bolt 8 pieces</p>
<p>#21</p>  <p>1/4" Washer 16 pieces</p>	<p>#22</p>  <p>Scoreboard 1 piece</p>	<p>#23</p>  <p>Shake flask 1 piece</p>	<p>#24</p>  <p>Billiard ball 1 set</p>	<p>#25</p>  <p>Cue rack 1 set</p>

Step 1

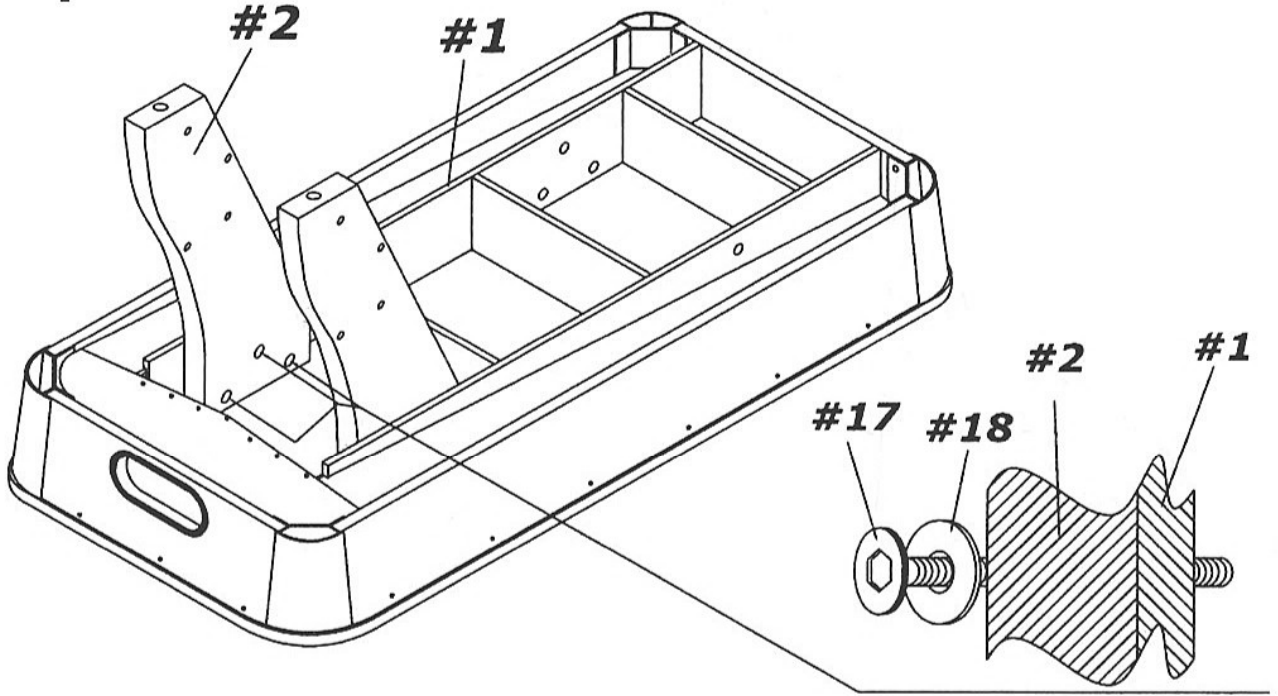

Step 2

