

POOL TABLE 8FT

INSTRUCTIONS

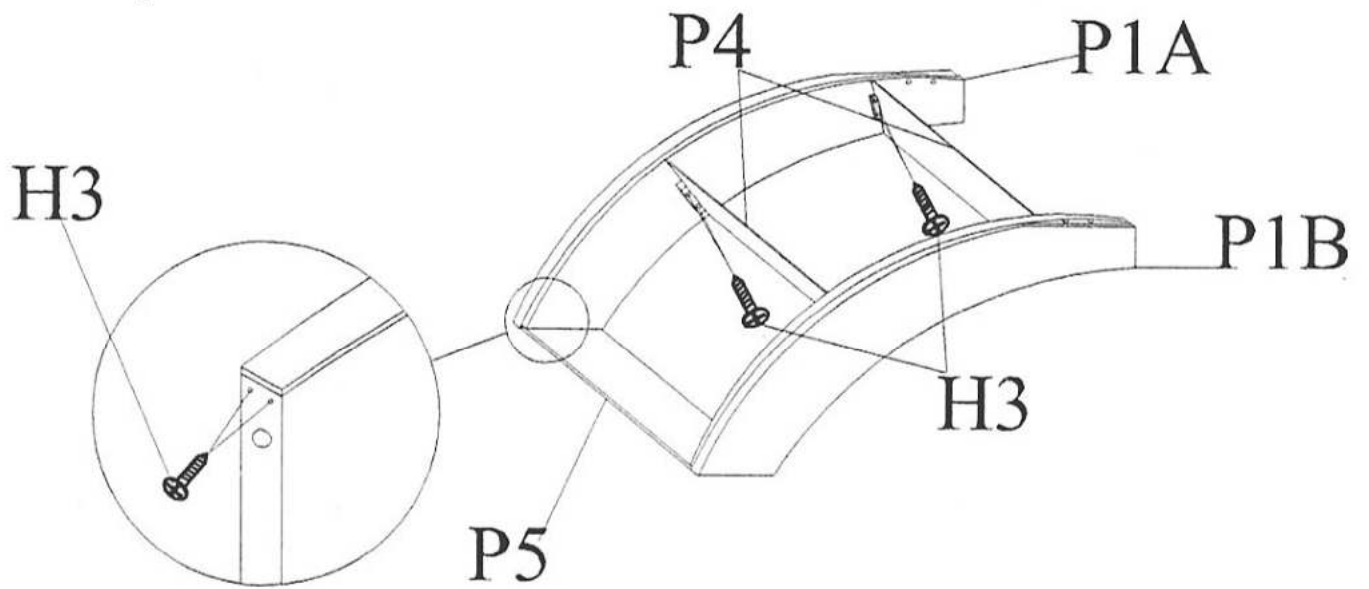

Step 1



Step 2

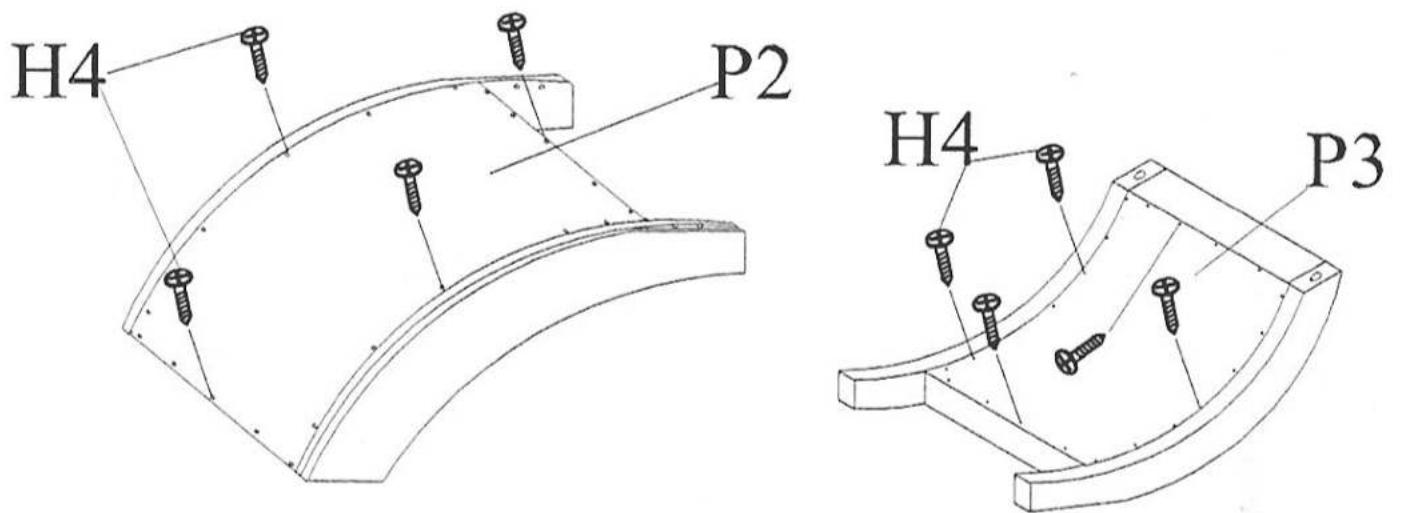

Step 3

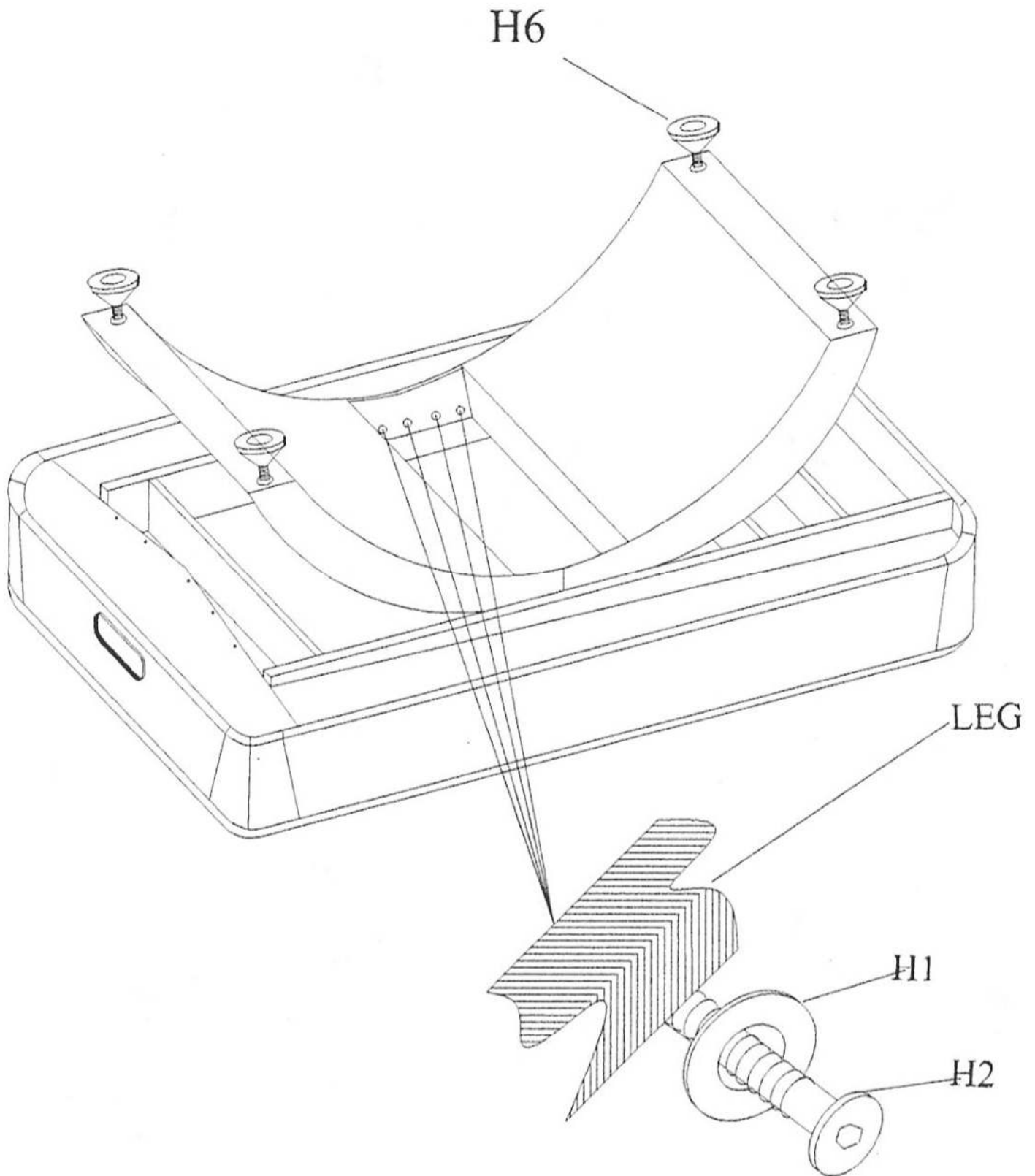

Part List

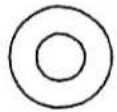

H1

5/16" FLAT WASHER

8

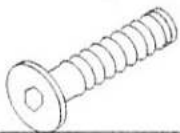

H2

5/16"X1-1/4" BOLT

8



H3

#8"X1-1/4" FLAT HEAD PHILLIPS SCREW 24



H4

#7"X5/8" ROUND HEAD PHILLIPS SCREW 84



H5

ALLEN KEY TOOL

1



H6

LEG LEVELER

4

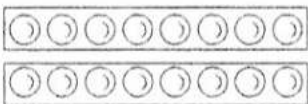

A1

BILLIARD BALL

1

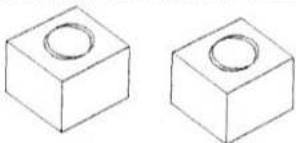

A2

CHALK

2

Part List



A3

CUE STICK

2

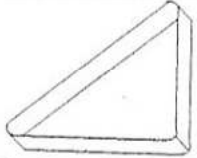

A4

TRIANGLE

1



A5

BRUSH

1



P1A

LEG A

2



P1B

LEG B

2

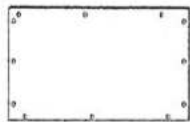

P2

LEG PANEL

2

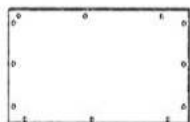

P3

LEG PANEL

2

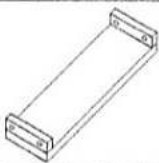

P4

LEG PANEL

4



P5

LEG PANEL

2